

# IRINOX

EasyFresh®  
Next

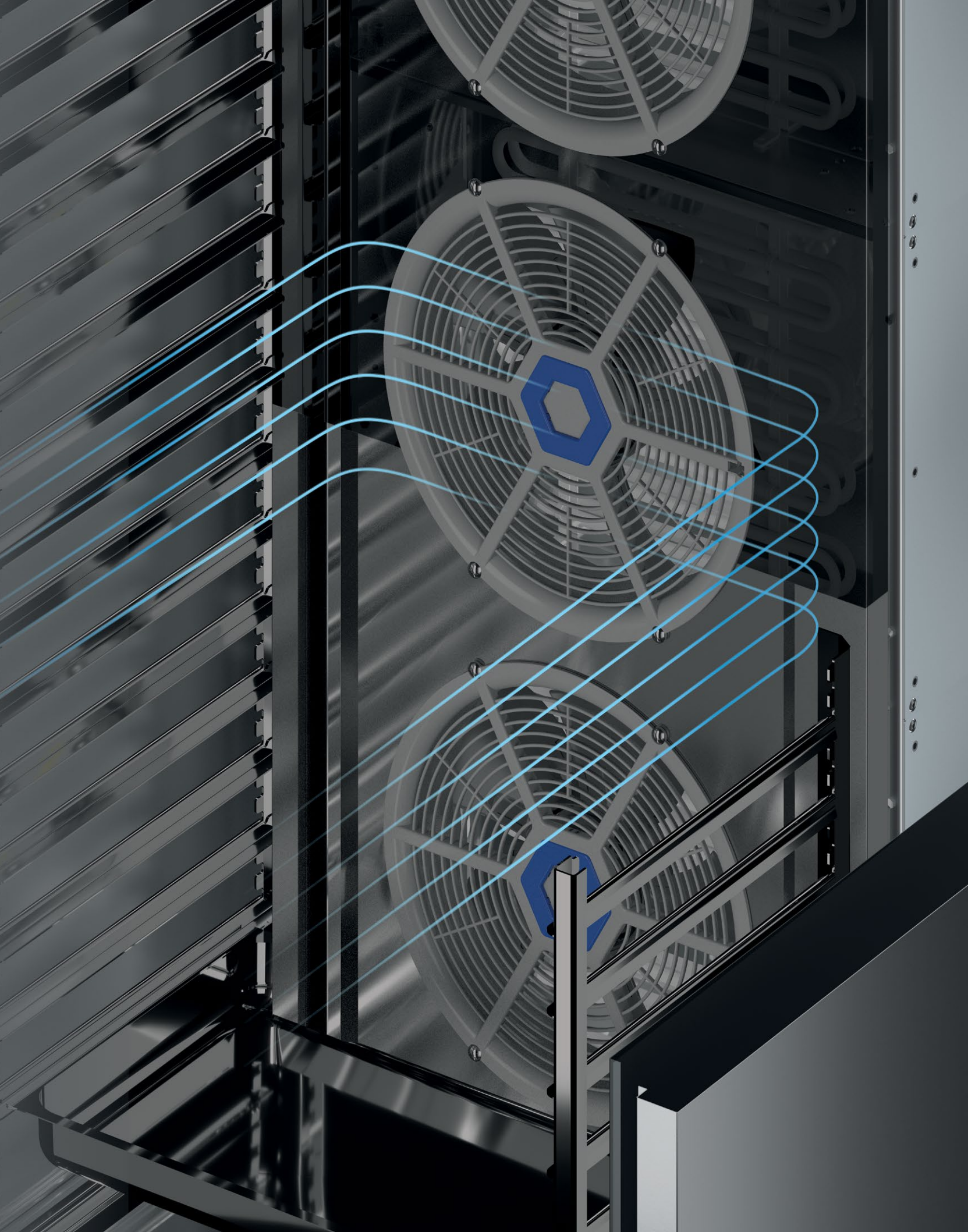



# The rapid blast chiller and shock freezer by Irinox

---

## – Next-level simplicity

1

EasyFresh® Next is intuitive and quick to programme. It offers 4 cycles for chilling and freezing, preserving product freshness for longer. This simple and reliable Irinox blast chiller is at your service in the kitchen.

---

## – Next-level performance

2

EasyFresh® Next guarantees high-performance, powerful and quick chilling and freezing. You can even insert hot products at very high temperatures, straight from the oven. The excellent performance offered by this Irinox blast chiller is always guaranteed, along with perfect product quality.

---

## – Next-level design

3

EasyFresh® Next has been completely redesigned for daily use of the blast chiller. Simplifying work means time saved and optimisation of processes in the kitchen. Every detail has been carefully designed and specially created, reaffirming the high-quality technology of Irinox blast chillers.



— EasyFresh® Next rapidly chills and freezes foods. No instructions needed: it is intuitive and quick to programme.

**Irinox blast chillers work by extracting heat as quickly as possible. Many years ago, we developed the delicate and strong cycles to ensure appropriate treatment of different foodstuffs, maintaining perfect quality: colour, consistency and softness are all guaranteed.**

#### **DELICATE +3°C**

- › Blast chilling cycle down to +3°C core temperature.
- › Designed for more delicate items such as mousses, creams, fish, rice, vegetables and items with a reduced thickness.

#### **STRONG +3°C**

- › Blast chilling cycle down to +3°C core temperature.
- › Ideal for items which are fatty, greasy, very dense, in large chunks or packaged, such as sauces, gravy, roasts or pasta casseroles.

#### **DELICATE -18°C**

- › Shock-freezing cycle down to -18°C core temperature.
- › Performed in two different phases - a positive one and a negative one - with very gentle ventilation.
- › This is recommended for leavened bakery products, bread and cooked items.

#### **STRONG -18°C**

- › Shock freezes foods with medium-large-sized pieces down to -18°C with air temperature reaching -35°C.
- › Also ideal for setting the shape of ice-cream, raw food or very thick cooked food items.



# 1 NEXT-LEVEL SIMPLICITY

## Why use a blast chiller?

To preserve original aroma, texture, colour and nutrients, locking in the essential properties of foodstuffs for longer.

EasyFresh Next® chilling cycles lower the core temperature of foodstuffs down to +3°C, quickly moving through the bacterial-growth danger zone (between +40°C and +10°C) which causes natural deterioration. The freezing cycles turn the water inside the foodstuffs into microcrystals and retain their structure and intrinsic qualities over time.

### – Chilling +3°C

Blast chilling halts the deterioration of foods, stops oxidation and reduces bacterial growth. EasyFresh® Next brings the core of products to +3°C from any starting temperature, even boiling hot, maintaining food properties. Healthier products with quality guaranteed for three times longer.

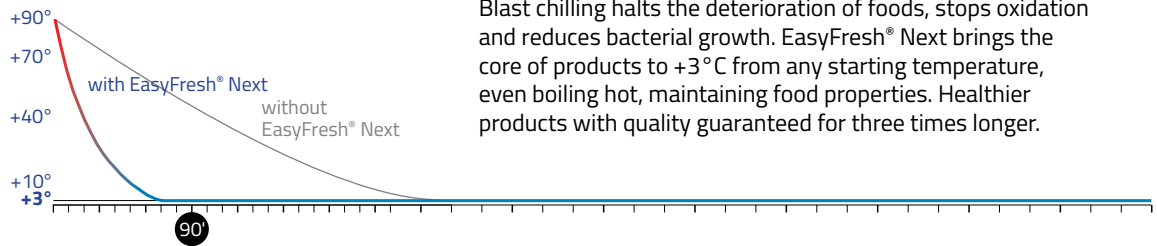

### – Freezing -18°C

Ultra-fast freezing, down to -18°C at the core, guarantees formation of microcrystals that do not compromise the structure of foods, maintaining flavour and aroma profiles, even after defrosting. Perfect products, just like fresh, which can be preserved for longer.

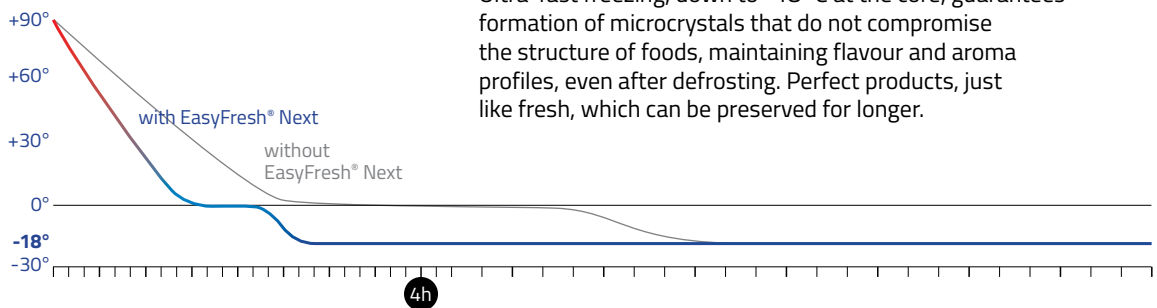

— EasyFresh® Next speeds up chilling processes, increasing productivity. The speed of cycles allows better organisation of production in the kitchen, optimising management of personnel and preparation of dishes.

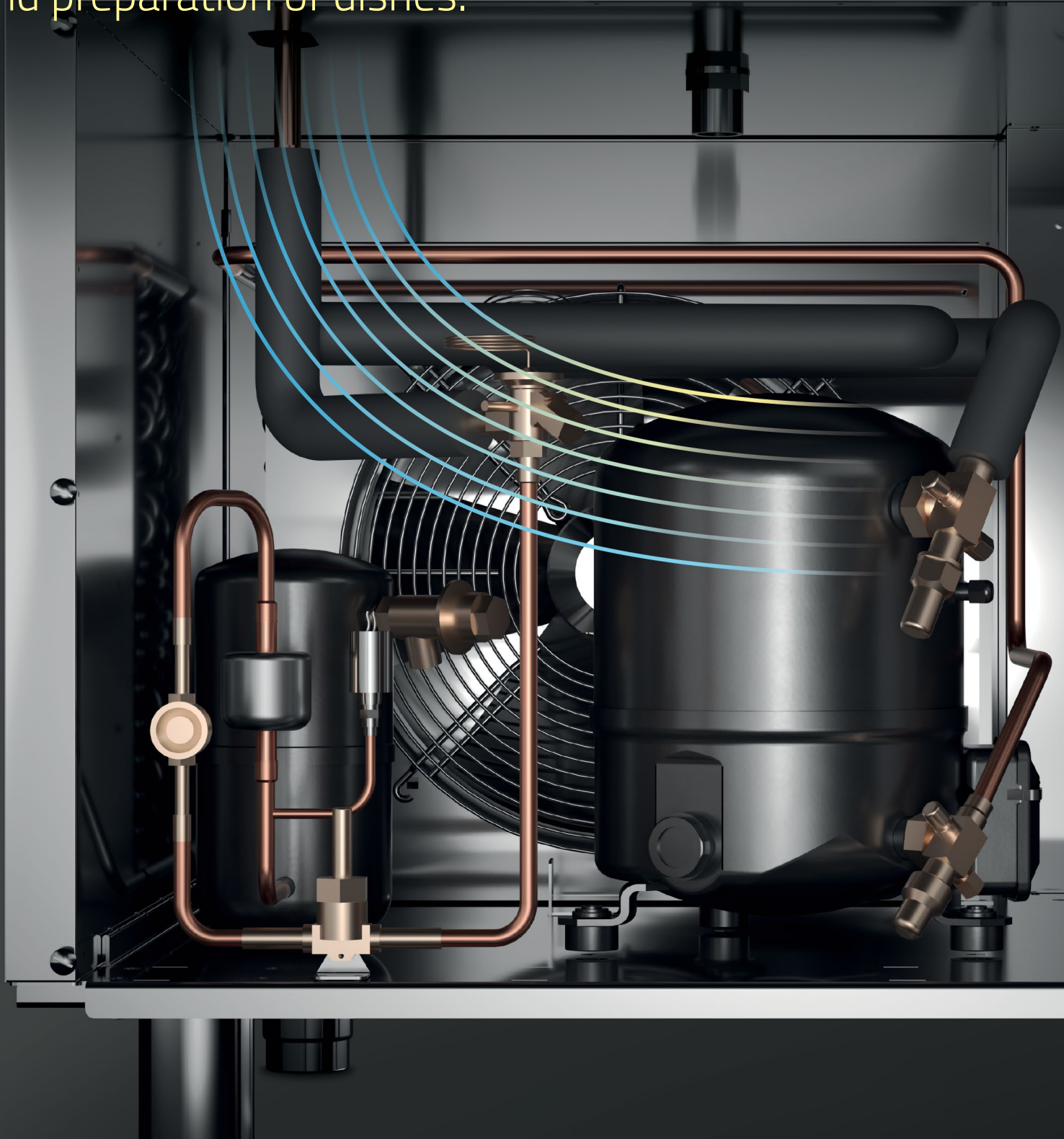





## 2 NEXT-LEVEL PERFORMANCE

In the same category  
no other offers  
the same performance

**EasyFresh® Next pays for itself with the time it saves.**

Rapidly chills and freezes rice, pasta, soups, fish, meat and even ice cream 30% quicker than other products, reducing energy consumption. All of this is achieved without compromising the flavour and aroma profiles of food. The speed offered by EasyFresh® Next allows better organisation in the kitchen, optimising management of processes and personnel.

### Speeds compared

	Maximum duration according to legislation	With EasyFresh Next*	Speed
 <b>Zucchini</b>	90'	42'	+53%
 <b>Sponge cake</b>	90'	71'	+21%
 <b>Chicken breasts</b>	240'	148'	+38%
 <b>Cream ice cream</b>	240'	105'	+56%

\* Tests performed in line with Irinox procedure using named products

### Irinox Balance System®

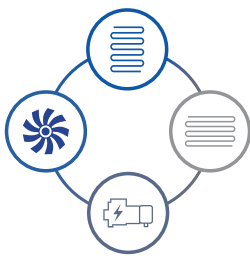

To guarantee optimal performance and efficiency, EasyFresh® Next is equipped with IrinoxBalanceSystem®: the perfect dimensions of the main refrigerator components (condenser, evaporator, compressor and fans) creates a balance between ventilation and humidity within the chamber, which is essential to preserve the structure and the flavour and aroma profile of foods.

— EasyFresh® Next has been developed by a team of designers and created with extremely high build quality. Unmistakeable high-quality Irinox blast-chiller technology.



---

#### GRID

The grid is located at the bottom of the blast chiller to facilitate the airflow: the new design improves recirculation by increasing capacity, ensuring optimised performance. The tilt opening simplifies access to the filter for cleaning.

---

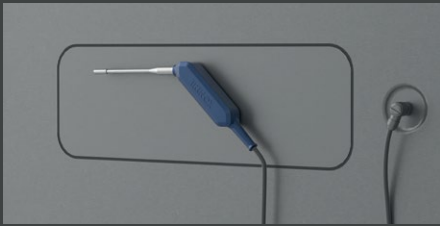

---

#### PROBE

The probe features a hexagonal design and even easier positioning: the inside of the door has a large magnetic surface for easy placement. Simplified corrosion-IP67 resistant fittings with screw connector.

#### HANDLE

A robust handle, easy to clean and with improved grip thanks to new ergonomic design. The handle design is one of this blast chiller's most distinctive features.





### 3 NEXT-LEVEL DESIGN

# Technology that makes life easier

Designed for high performance and intuitive use.



#### FLUSH HINGES AND DOOR

The full-height door features bevelled edges and patented hinges with standard opening of 160° which can be easily cleaned. These can be set to 115° to avoid interference with nearby equipment and feature an automatic return mechanism.

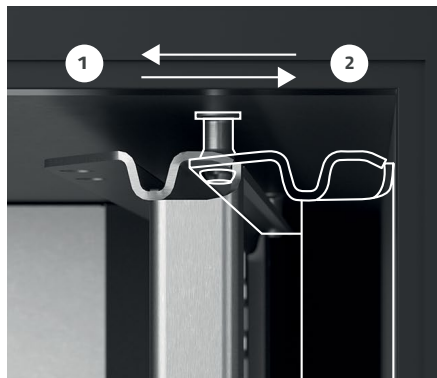

#### MULTIRACK

The distance between trays can be adjusted via the MultiRack system. This allows use of both pastry (2) trays and those for other types of foods (1). MultiRack guarantees perfect distribution of air across all levels.



#### SANIGEN

Sanigen® releases active ions that act on the microbial load present in the air and on surfaces, including foodstuffs. It reduces contamination and bacterial load in the air by up to 99%, also in inaccessible areas such as the evaporator.

# — The range

## EF Next XS



### OUTPUT PER CYCLE

❄️ 10 kg ❄️ 10 kg

### TRAY CAPACITY

GN1/1 (H=65 mm) > 3  
GN1/1 (H=40 mm) > 3  
GN1/1 (H=20 mm) > 3

### TECHNICAL SPECIFICATIONS

**Dimensions** 535×655×740 mm  
**Weight** 72 kg  
**Gas** R452

### ELECTRICAL SPECIFICATIONS

Ⓜ 1 kW Ⓜ 5 A  
Ⓥ 230V-50Hz (1N+PE)

## EF Next S



### OUTPUT PER CYCLE

❄️ 18 kg ❄️ 15 kg

### TRAY CAPACITY

GN 1/1 or 600×400 (H=65 mm) > 4  
GN 1/1 or 600×400 (H=40 mm) > 5  
GN 1/1 or 600×400 (H=20 mm) > 8

### TECHNICAL SPECIFICATIONS

**Dimensions** 790×840×870 mm  
**Weight** 115 kg  
**Gas** R452

### ELECTRICAL SPECIFICATIONS

Ⓜ 1.3 kW Ⓜ 6.2 A  
Ⓥ 230V-50Hz (1N+PE)

## EF Next M



### OUTPUT PER CYCLE

❄️ 38 kg ❄️ 35 kg

### TRAY CAPACITY

GN 1/1 or 600×400 (H=65 mm) > 9  
GN 1/1 or 600×400 (H=40 mm) > 12  
GN 1/1 or 600×400 (H=20 mm) > 18

### TECHNICAL SPECIFICATIONS

**Dimensions** 790×920×1590 mm  
**Weight** 160 kg  
**Gas** R452

### ELECTRICAL SPECIFICATIONS

Ⓜ 2.7 kW Ⓜ 4.4 A  
Ⓥ 400 V-50Hz (3N+PE)

## EF Next L



### OUTPUT PER CYCLE

❄️ 50 kg ❄️ 45 kg

### TRAY CAPACITY

GN 1/1 or 600×400 (H=65 mm) > 13  
GN 1/1 or 600×400 (H=40 mm) > 18  
GN 1/1 or 600×400 (H=20 mm) > 27

### TECHNICAL SPECIFICATIONS

**Dimensions** 790×920×1965 mm  
**Weight** 190 kg  
**Gas** R452

### ELECTRICAL SPECIFICATIONS

Ⓜ 4.1 kW Ⓜ 7 A  
Ⓥ 400 V-50Hz (3N+PE)

### Output in kg

❄️ from +90 to +3°C ❄️ from +90 to -18°C

Tests performed in line with Irinox procedure using pieces of beef with a thickness of 5 cm

**Dimensions** W × D × H

### Electrical specifications

Ⓜ max power rating

Ⓜ max current rating

Ⓥ voltage

## Standard features

- > Air condensation
- > Left-hand door opening
- > Core probe (1 measurement point)
- > Feet adjustable in height from 80 to 115 mm (EF Next S)
- > Feet adjustable in height from 115 to 165 mm (EF Next M and L)
- > MultiRack
- > USB kit for downloading HACCP data
- > Refrigerant gas R452

## Optional features available upon request

### RIGHT-HAND DOOR OPENING



### WHEELS

With and without brake

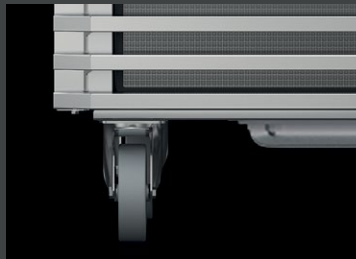

### SANIGEN®



## **IRINOX**

### Head office

via Madonna di Loreto, 6/B  
31020 Corbanese di Tarzo  
Treviso, Italy

### Operating facility

viale Enrico Mattei, 20  
Z.I. Prealpi Trevigiane  
31029 Vittorio Veneto  
Treviso, Italy  
Tel +39 0438 2020

[irinoxprofessional.com](http://irinoxprofessional.com)

